

# Tubulares 35mm

adaptadores herrajes y punteras



## adaptadores

Ø 35mm

### H01 + L 02 A

Código: 3040160 / 2040440

Conjunto para tubo redondo de 45mm

Para Ø 35



### H06 + L08

Código: 2040145 / 2040465

Conjunto p/ tubo octogonal de 40mm

Para Ø 35

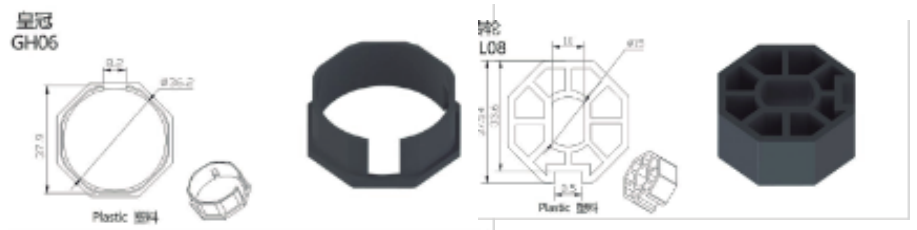

### H178 + L02

2040242 / 2040440

Conjunto para tubo Redondo 50mm

Para Ø 35

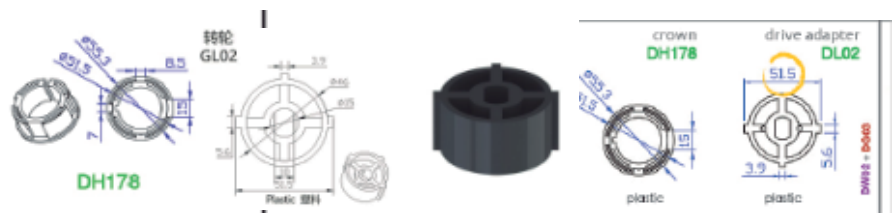

### H 21 + L 34

2040275 / 2040600

Conjunto para tubo redondo de 40mm

Para Ø 35



**H41/L53**

**2040295 / 2040640**

Conjunto para tubo nervado de 47mm

Para Ø 35



**H42/L55**

**2040305 / 2040645**

Conjunto para tubo redondo de 47mm

Para Ø 35

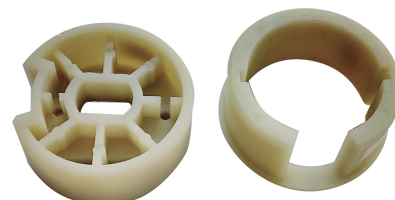

**H71 + L82**

**2040380 / 2040720**

Conjunto para tubo redondo de 50mm

Para Ø 35

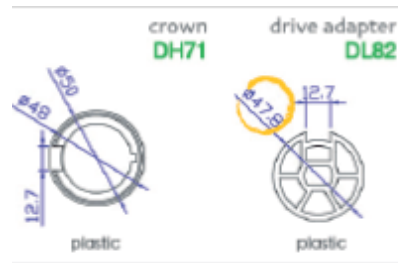

**H83 + L96**

**2040400 / 2040740**

Conjunto para tubo nervado de 50mm

Para Ø 35



**W01A + L01**

**2050470 / 2040430**

Driver para tubo de 38mm

Para Ø 35

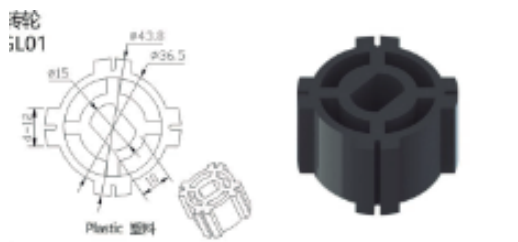

**H 55 + L 65**

**2040340 / 2040680**

Conjunto para tubo redondo de 43.6mm

Para Ø 35

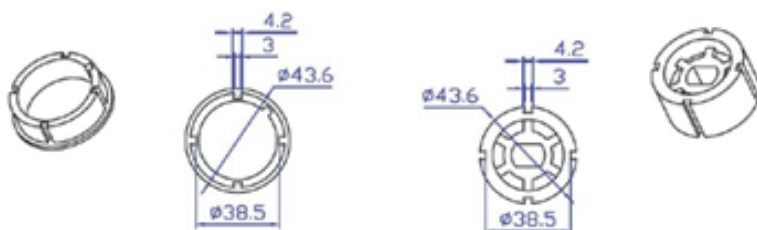

# herrajes | Ø 35mm

## Techo y Pared Z01 / Z02

Para Color Blanco usar sufijo "A", sin sufijo Color Negros.

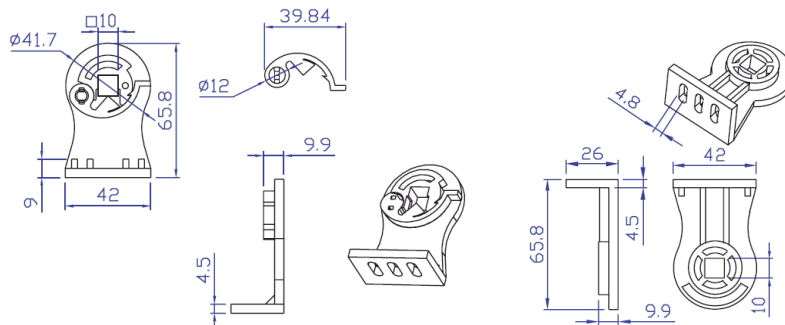

## Z319B

Bracket DM35/45 x 2u ambos+ dw 02

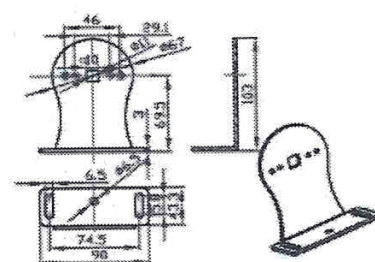

## Cuna Metálico Z 03

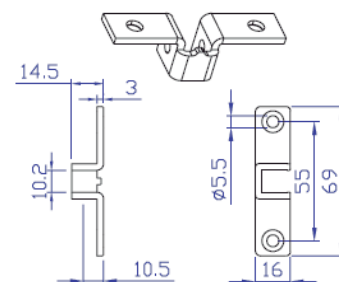

## Omega Z04

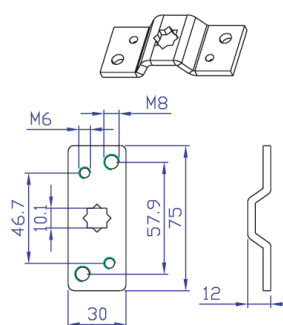

## Z43/Z44

Conjunto de Soportes en Chapa Galvanizada para Techo y Pared

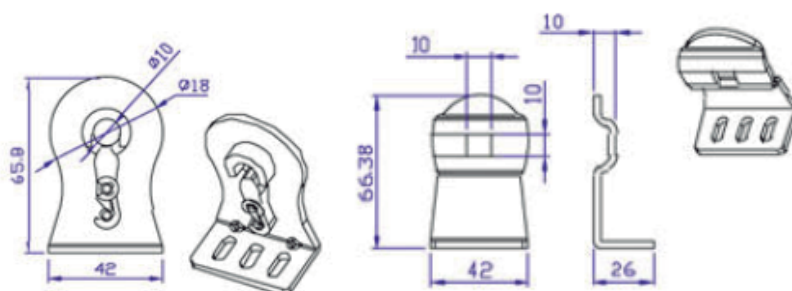

**Z126**

Soporte metálico en L Con Bulón M10 incorporado

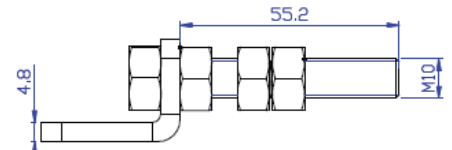
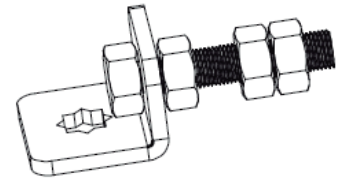

**Z107**

Conjunto de Soporte Metálico en L con Ruleman  
Ajustable en altura para Techo y Pared

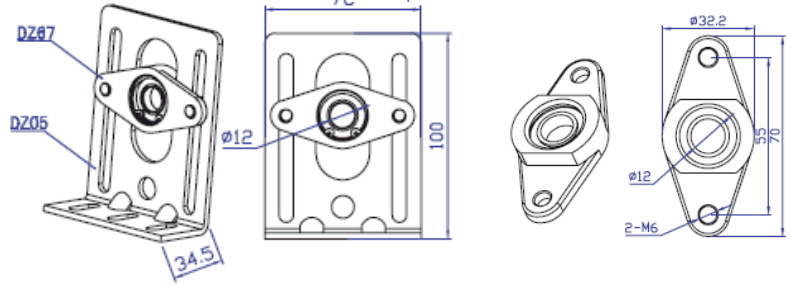

**Z 04 y Z 05**

Conjunto de Soporte Metálico en L lado Motor  
Ajustable en altura para Techo y Pared

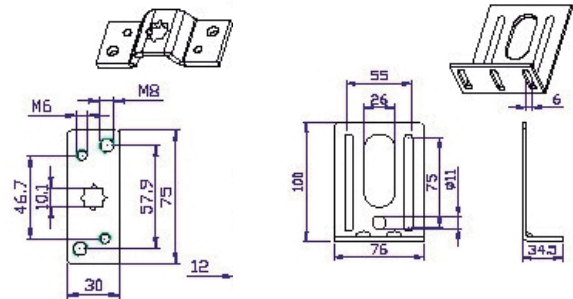

**Z318**

Unión doble de tubo 50mm DM 35/45 redondo

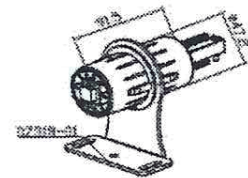

(Middle support)

**punteras** | Ø 35mm

**W13**

Para caño octogonal de 40,5mm

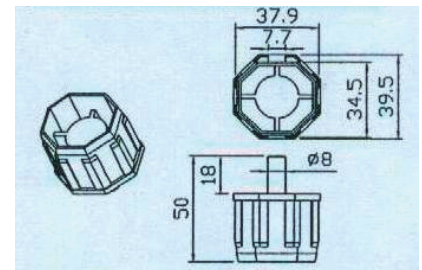

**W02**

Puntera de 50mm redondo DM 35/45

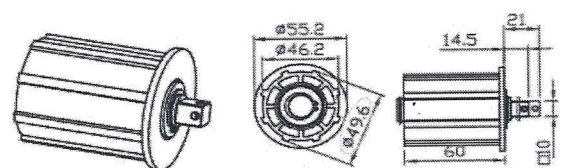

DW02