

adaptadores

Ø 35mm

H01 + L 02 A

Conjunto para tubo redondo de 45mm
Para Ø 35



H06 + L08

Conjunto p/ tubo octogonal de 40mm
Para Ø 35

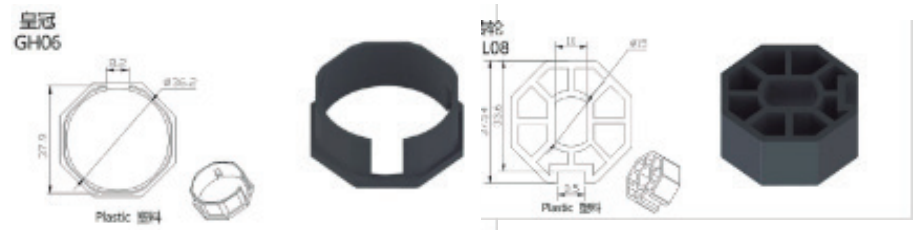

H178 + L02

Conjunto para tubo Redondo 50mm
Para Ø 35

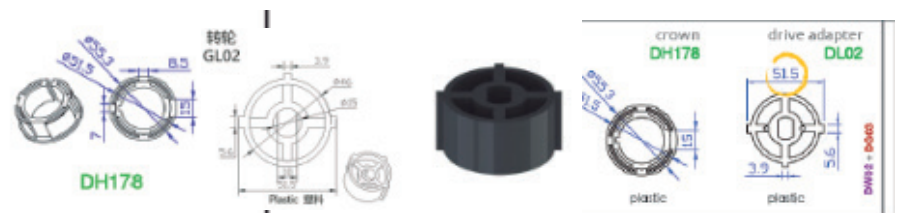

H 21 + L 34

Conjunto para tubo redondo de 40mm
Para Ø 35



H41/L53

Conjunto para tubo nervado de 47mm

Para Ø 35



H42/L55

Conjunto para tubo redondo de 47mm

Para Ø 35

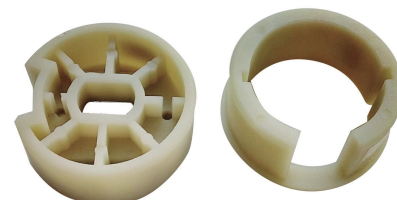

H71 + L82

Conjunto para tubo redondo de 50mm

Para Ø 35

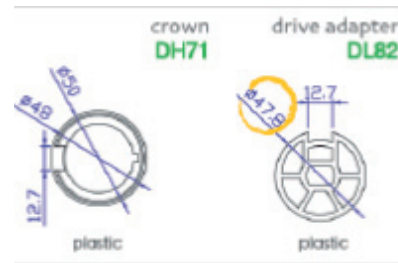

H83 + L96

Conjunto para tubo nervado de 50mm

Para Ø 35



L01

Driver para tubo de 38mm

Para Ø 35

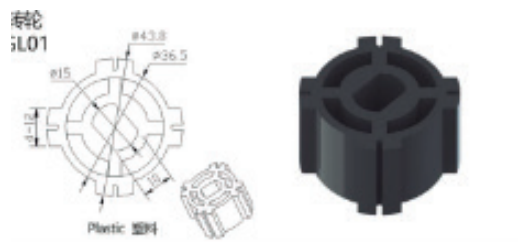

H 55 + L 65

Conjunto para tubo redondo de 43.6mm

Para Ø 35

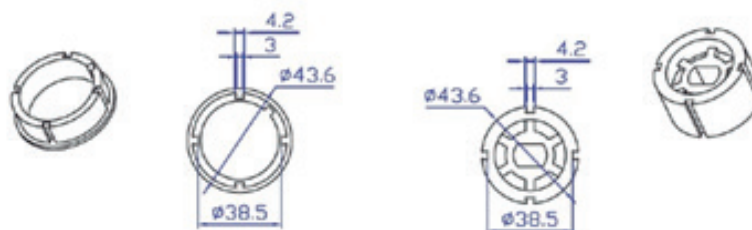

herrajes | Ø 35mm

Techo y Pared Z01 / Z02

Para Color Blanco usar sufijo "A", sin sufijo Color Negros.

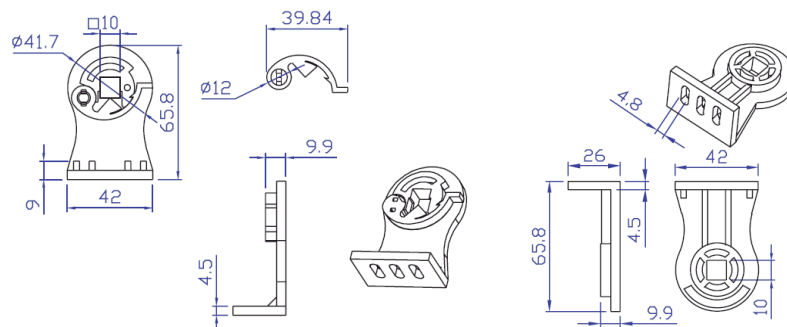

Z319B

Bracket DM35/45 x 2u ambos+ dw 02

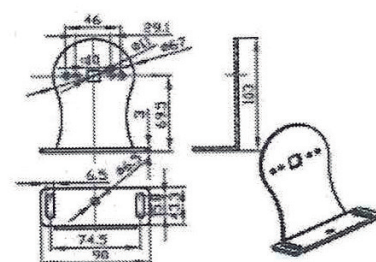

Cuna Metálico Z 03

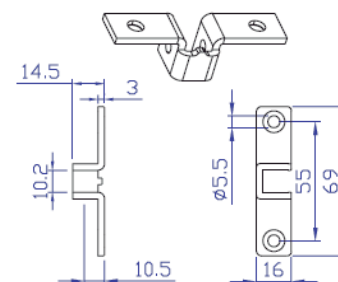

Omega Z04

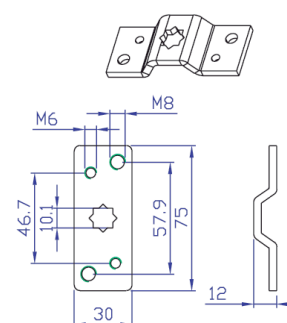

Z43/Z44

Conjunto de Soportes en Chapa Galvanizada para Techo y Pared

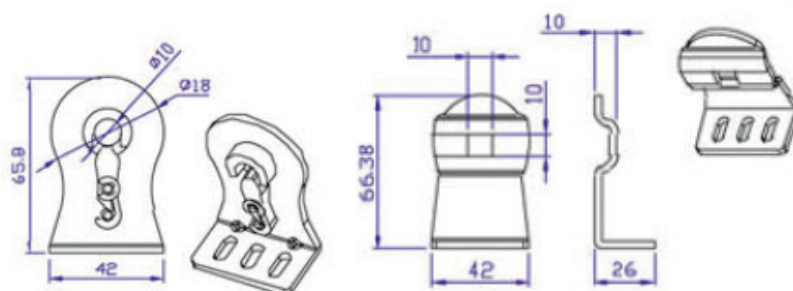

Z126

Soporte metálico en L Con Bulón M10 incorporado

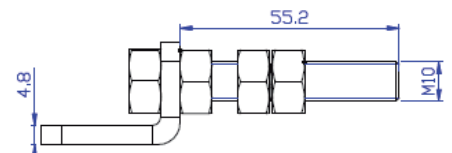
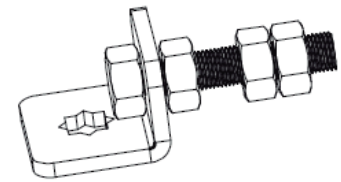

Z107

Conjunto de Soporte Metálico en L con Ruleman
Ajustable en altura para Techo y Pared

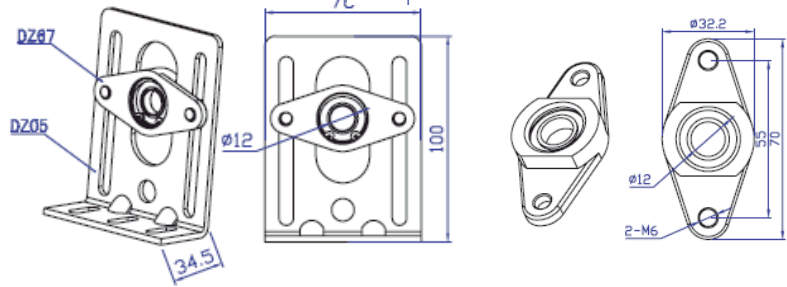

Z 04 y Z 05

Conjunto de Soporte Metálico en L lado Motor
Ajustable en altura para Techo y Pared

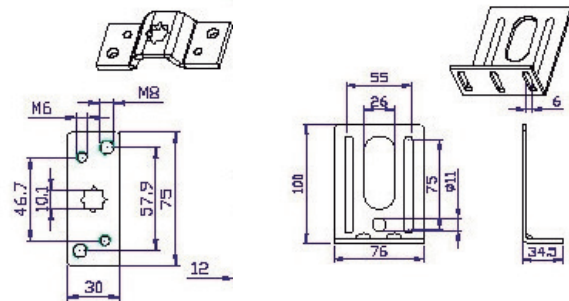

Z318

Unión doble de tubo 50mm DM 35/45 redondo

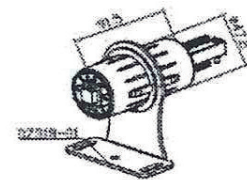

(Middle support)

punteras | Ø 35mm

W13

Para caño octogonal de 40,5mm

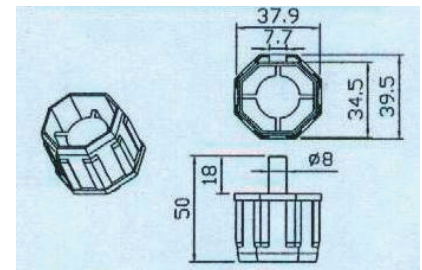

W02

Puntera de 50mm redondo DM 35/45

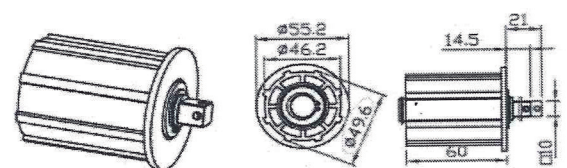

DW02